

Article number: 20141V45B452BL

Description: E+G two-way connecting clamp  
GN141-V45-B45-2-BL

## Measures

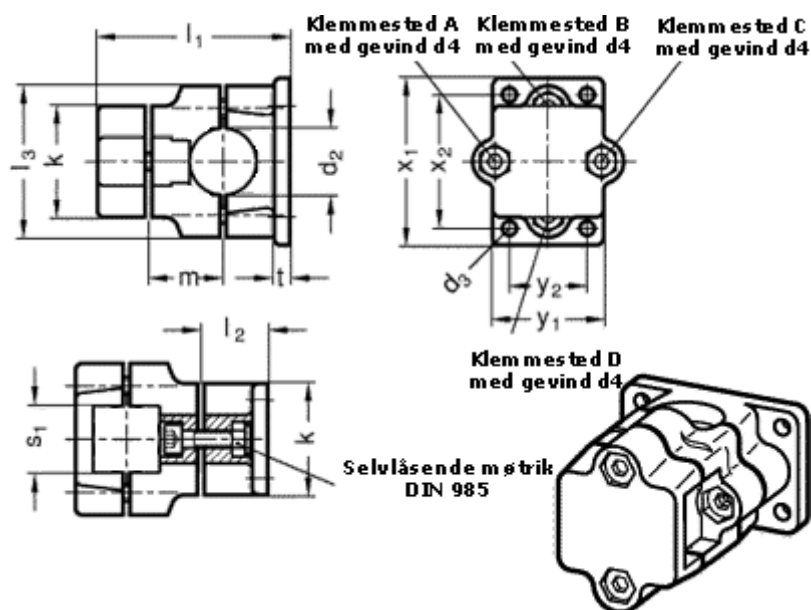

Adjustable clamp lever = GN 911-M10-63 have to be ordred separately

d2	= 45
d3	= 11
d4	= M10
k	= 76
l1	= 136
l2	= 46
l3	= 98

m = 55
s1 = 45
t = 14
x1 = 115
x2 = 90
y1 = 76
y2 = 50